

Artemide®

Meteorite 35

design
Pio & Tito Toso

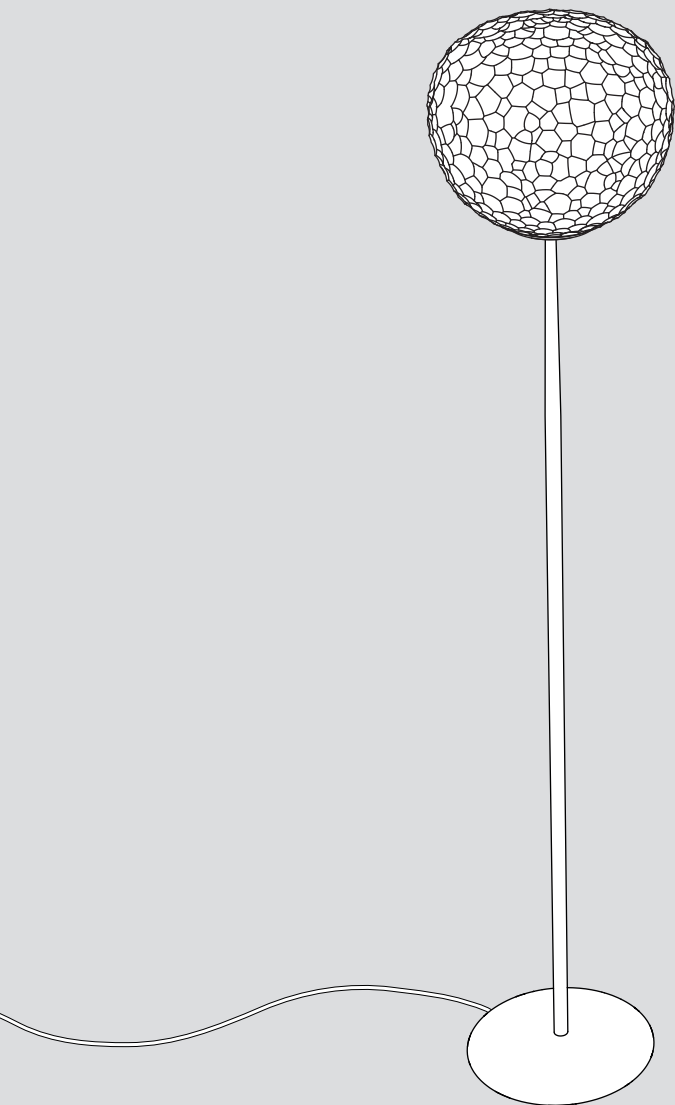



i

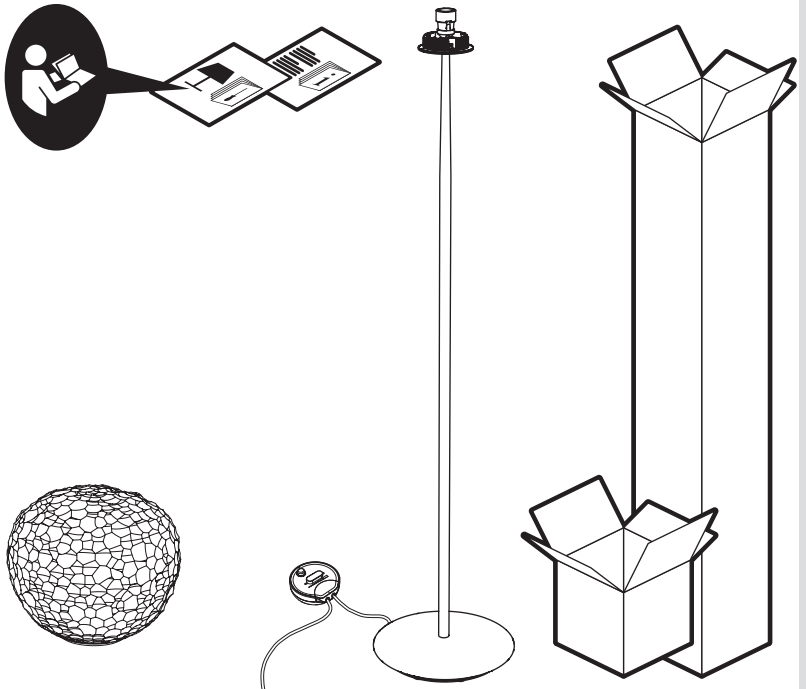
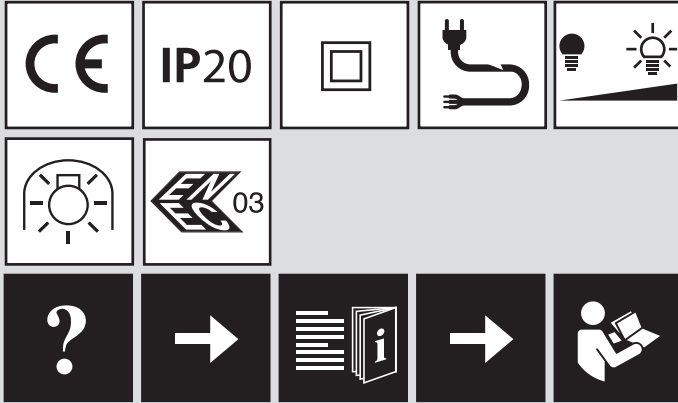

1

E27 - MAX 150W

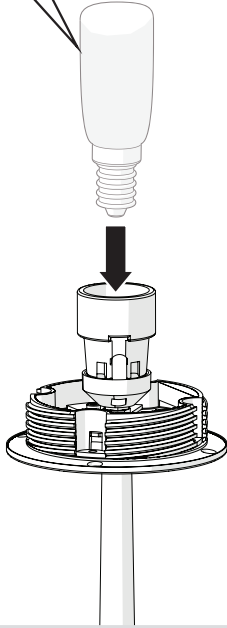

2

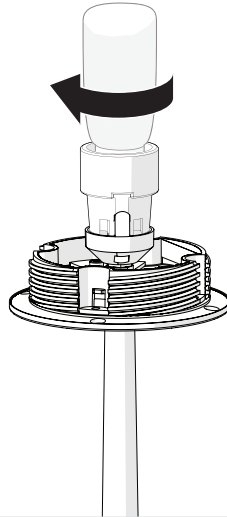

3

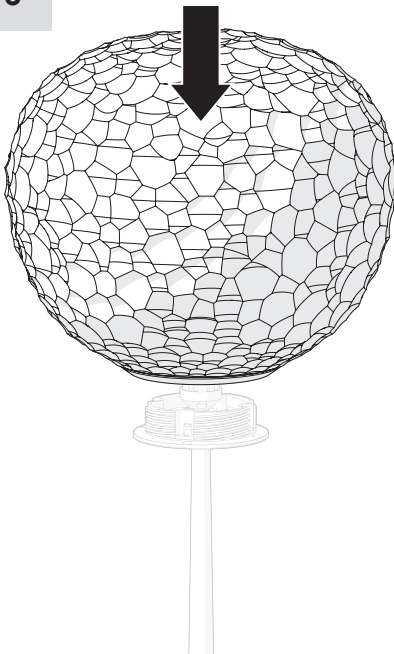

4

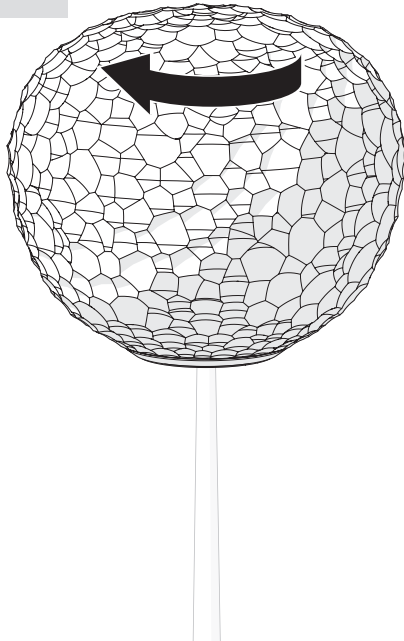



5

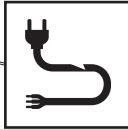
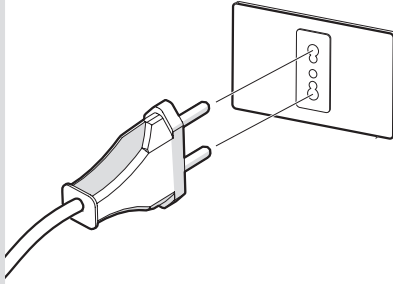

6

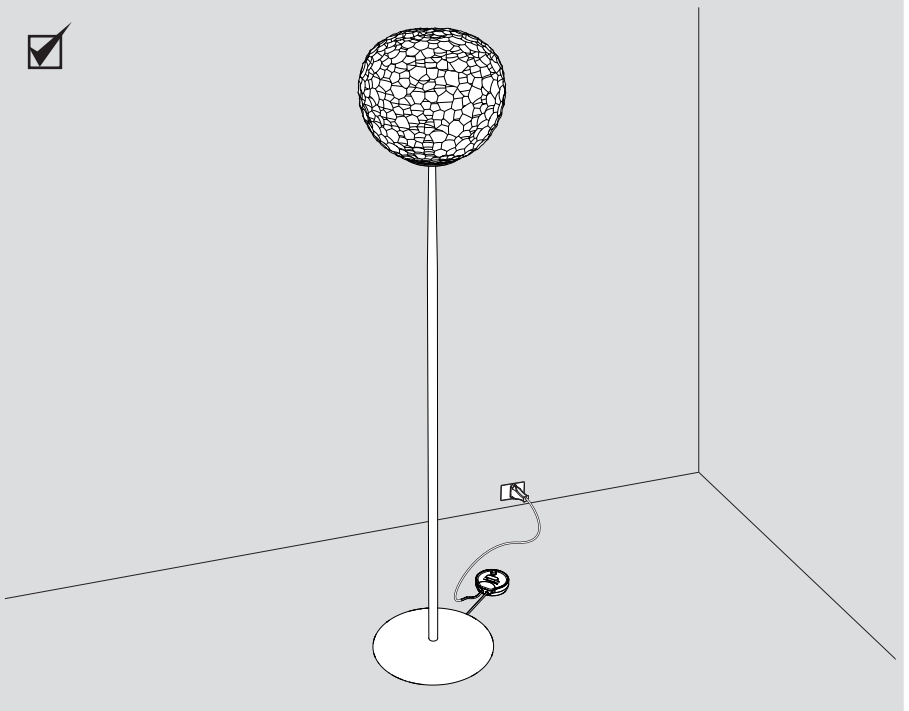
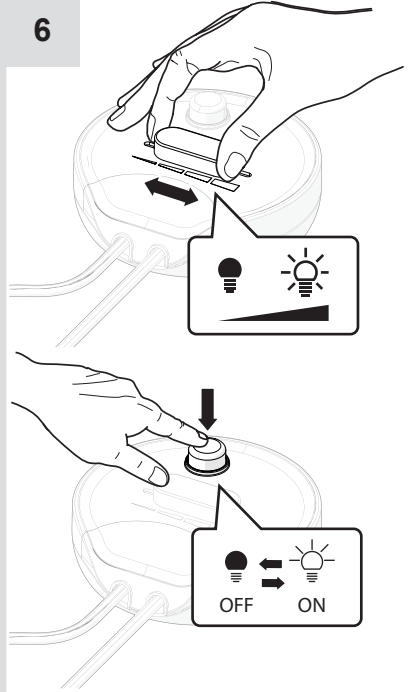



i

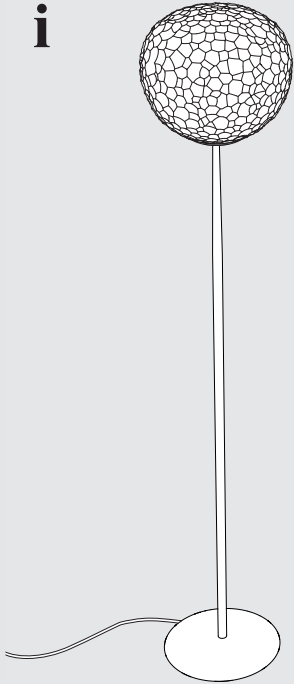

MAX 150W - E27

Halo: HSGST - 2900 lm

LED: DRAA - 2500 lm

1

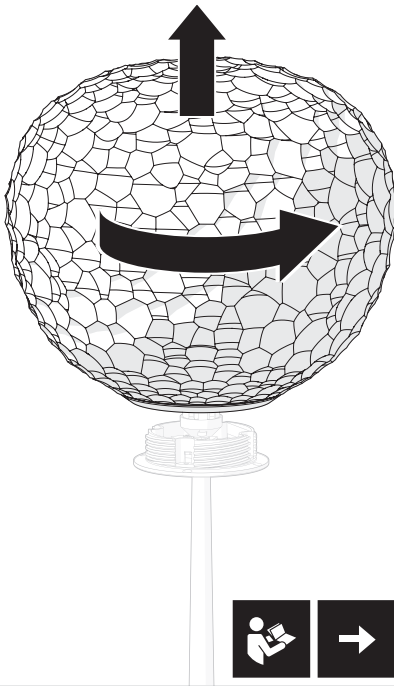

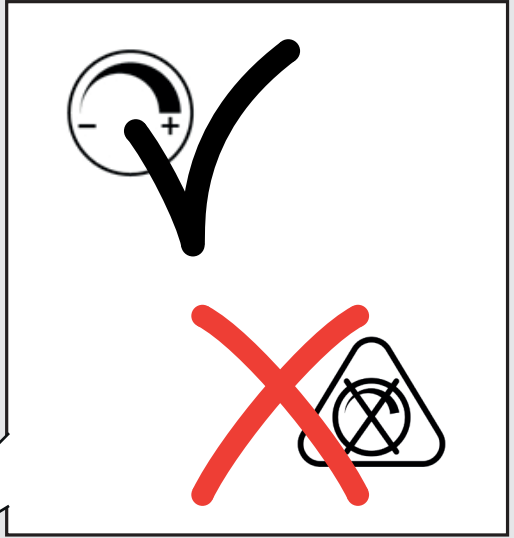
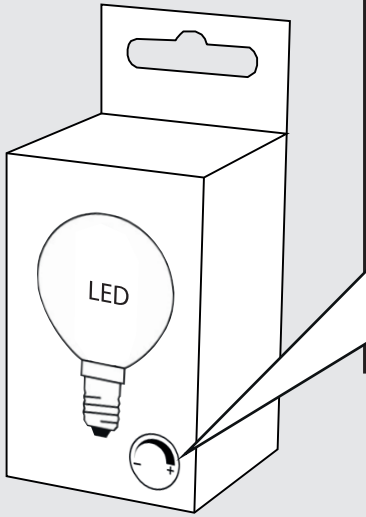

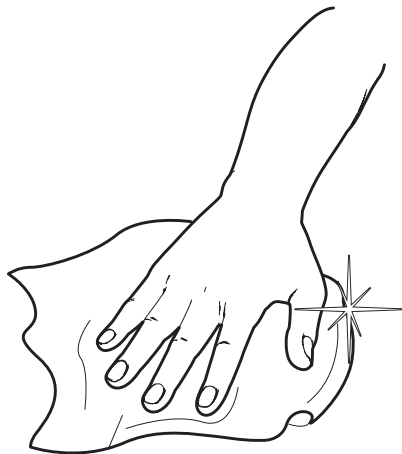
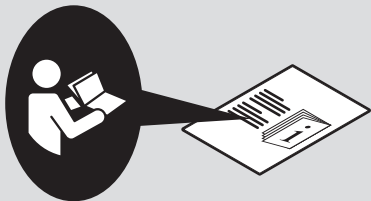

Artemide®



Artemide

via Bergamo, 18
20010 Pregnana M.se (MI)
ITALIA

tel. +39 02 935 181
fax +39 02 935 90 254
fax +39 02 935 90 496

www.artemide.com

VAT IT00846890150

cod. Y513000573